

Switching and Distribution Products Systems & Modules

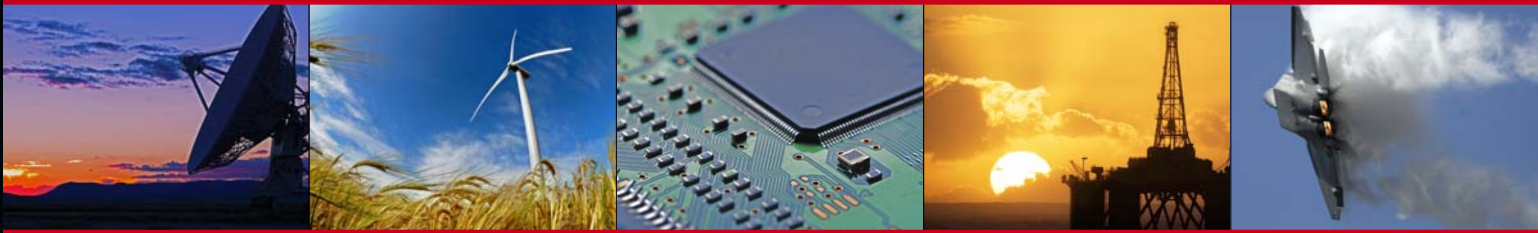

Short Form 2017A



Communications - Telemetry - Automated Testing - Broadcast



Global Signal Switching and Distribution Specialists

Made in the USA

C ontents

Page

- The Company 3
- Applications and products photo gallery 4 - 5
- Rack Mounted Modular Switching Solutions: Series G2 (DC-40GHz) 6 - 7
- New!** - Modular 64x256 Switching System: SLX320 (IF, L-Band and S-Band) 8
- Model RM1X2 (DC-3GHz) 8
- New!** - Modular 32x32 Switching System: SLx32 (IF, L-Band and S-Band) 9
- New!** - Fixed Size 16x16 L-Band & IF Switching System: SLM16 & SIM16 9
- Critical Application System Solutions: Series **G2-CAS** (DC-30GHz) 10
- New!** - Low Cost HDSOI & Analog Routers and Distribution Amplifiers: VSUX, HDVSUX, VDU1, DDU32 .. 10
- New!** - Distribution, Conversion and Switching (analog, digital & fiber): Linker System LS1601A 11
- New!** - Microwave Switchers DC-18GHz: System MS2010A, MSD0601 and MS06X02 11
- New!** - Flexible Rack Mounted Systems from 32x32 to 1024x1024: S2560FX, S2561FX and S2562FX .. 12
- New!** - Pre-Configured G2 Configurations (touchscreen): TS2 Systems (formerly SS2) 13
- New!** - Redundancy Switching Units: System RSX4 (single, dual or quad channel) 13
- Rugged Coaxial Relays and Chassis: Series U70000 and URS70000 (formerly Matrix Systems Corporation) 14 - 15
- New!** - RS530 Switch Systems for Satellite (FDMA, CDMA, TDMA): System S24530A, S64530A 16
- VXIbus Switching Modules and Mainframe (Legacy) 17
- New!** - Control and Monitor Software: **RouteWarePRO 5.0** 17
- Remote Control Options 18
- Quality Management System: ISO 9001-2008 18
- Factory Authorized Representatives: Domestic and International Cover



Hot-Swap power supplies & modules
Most products feature hot-swap monitored supplies, control CPUs, and modules



Quality construction, plating, and hardware
Rack mounting is built into most products. Only stainless steel hardware is used throughout for longevity



Plug-in C3 Controllers with LXI, SNMP & IPv6
Latest in hot-swap control interface technology

What does **New! mean?**
We are constantly improving existing products and creating new ones. If you see this red highlight, this is something new/improved and exciting!

On Cover
Showing "systems and modules", see our new System S256xFX on page 12, and the relay module RM1X2 on page 8.



A

bout the Company

Global Leader in Switching Technology

Universal Switching Corporation is an internationally recognized leader in the switching industry that manufactures "state-of-the-art" switching and distribution equipment. Since 1992, the USC commitment to Continuous-Process-Improvement and cutting-edge technology has been combined to provide a unique blend of cost effective and high quality products.

With a corporate culture that includes a modern facility in Burbank, talented personnel, comprehensive Quality Management System and **ISO 9001:2008 certification**, USC provides a standard 2-Year warranty for all equipment, and optional 5-Year warranties.

Product Line Offering

A broad product line of switching systems, switching modules and distribution units span a frequency range from DC to 40GHz. Signal types include AC/DC power switching, audio, ATE instrumentation, composite video, SD, HD, 4K, HF, RF, IF and L-Band signals, high resolution RGB+HV video, high speed 422, LVDS, PECL or ECL digital data, small and large L-Band products, plus other >3GHz signals all the way to 40GHz.

Embedded controllers and software are utilized throughout the product line to provide fast, accurate and easy control and monitoring. Adapter panels and remote control panels provide configurability to meet unique interface and control requirements.

Product Line Expansion and Legacy Items

With the acquisition of Matrix Systems Corporation's (MSC) switching product line in 2007, the USC product line now includes a number of unique relay modules in support of existing system installations throughout the world. A number of USC product enhancements have further improved this proven product line.

COTS Solutions

Leading the automated switching industry with the largest cross-point capacity, programmable switching systems and modules are available in "off the shelf" configurations to solve time-sensitive switching requirements. Rather than long lead times for special, modified or custom ordered equipment like other manufacturers, USC's "off the shelf" configurations provide turn-key solutions in real time by utilizing the full spectrum of current technology coupled with the latest in design and manufacturing techniques.

In addition to "turn-key" solutions, USC provides custom or OEM systems and modules with minimal lead time and expedited delivery. USC specializes in switching and distribution products and equipment which supports or connects to switching equipment, but also has resources and engineering expertise to fulfill any switching related need including requirement evaluation, system design, translation, distribution and system integration.

Switching Experience

With a core competency in the switching arena, USC is focused on switching and distribution needs within a variety of industries and the direction of future requirements. A range of USC products are used in the most sensitive of areas requiring high reliability like aerospace and defense, surveillance stations, satellite communications, as well as "everyday" production testing and evaluation applications.



Global Signal Switching and Distribution Specialists

G2 Series (G2T)

The G2 Series modular product line continues to evolve and offers a host of features and improvements including high performance configurations, fully shielded modules, hot-swap module technology, field-upgradeable firmware, plus optional redundant CPU and power supply configurations. Ethernet (TCP/IP) control has been a USC standard for more than 15 years while other manufacturers are just now embracing the technology. Our C3 CPU is LXI compliant with TCP/IP, and has a host of new capabilities including a USB control port, SNMP and IPV6. A new C3-Lite controller is being introduced where legacy needs don't need to be met.



Our G2T touchscreen rack mount mainframes
Model G2T4 2RU mainframe and controller

Modular products are typically more cost effective than trying to configure "dedicated purpose" boxes that are the mainstay for many of our competitors. The advantages of our modular systems offered, like our G2 Series, are as follows:

- Flexible system architecture
- Hot swap power supplies via front panel
- Efficient modular design
- Common control and command protocol
- Compact physical format
- Multiple configurations in one box
- Simple logistics for sparing items

Scalable Switching Arrays

The scalable design concept used in the revolutionary System S256xF combines the latest in component technology and advanced control and monitoring features. The scalable design is suitable for data, telemetry or digital data, and up to 1024x1024 in a compact 5RU rack mounted "building-block" package. The System S256xF features hot-swap modules and hot-swap power supplies as standard features with optional dual CPUs to meet unique switching control and system requirements.

Technological Accomplishments

Globally recognized industry accomplishments include our evolving field proven G2 Series product line introduced in 2001, the revolutionary System S256xF units, C3 Controller, and our new compact high performance digital and analog product lines. Most of our new or upgraded products are highlighted in this short form.

Product Development

Ongoing product development is the driving force behind advanced and innovative designs. USC continues to lead rather than follow the switching industry by investing resources in research and development. New digital types, LXI standards, Tri-Stage, touchscreens, and the rugged CAS (Critical Application System) represent the corporate commitment to Continuous-Process-Improvement and product development.

New product development and designs are regularly introduced on our website, but feel free to contact one of our engineering representatives or the factory directly for consultation. We are confident that a solution to your technical requirement is available.



Call and get our 25 Year Anniversary 4G USB stick with all our information and software.

A

pplications and products

- L-Band, S-Band or X-Band switching and distribution
- RF-Over-Fiber modules and systems
- Uplink / Downlink switching or IRIG timing distribution
- High speed TTL, '422, '232, LVDS, PECL and ECL data switching
- ATE test stations for routing test points to test equipment
- 4KHD, HD-SDI, SDI, and NTSC video switching
- Low noise antenna routing to HF receivers
- Rugged airborne surveillance signal switching
- Microwave signal switching (DC to 40GHz)
- High power AC or DC switching (10-90 amps)
- Radar X-Y-Z data, and radar video routing
- Telecommunication routing and broadcasting
- Switching inputs from RF analyzers to UUT's
- Instrumentation control and monitoring
- RGB+HV video and audio routing and distribution

New!
Series MR188
 Plug-in microwave relays
 (DC-18GHz)

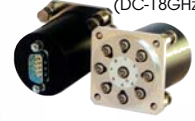

New!
System SLX320 and SIX320 L-Band and IF Systems
 Modular configurations up to 64x256
 Page 8



New!
System S256FX Digital/Analog Switch
 Scalable from 32x32 to 1024x1024
 Page 12



New!
System RSX4 Redundancy Switch
 Up to four channels, many plug-ins
 Page 12



New!
Series HDVMU1
 Low cost SDI video muxes
 4Ksdi HDsdi, SDI & NTSC (1RU)
 Page 10

4K HDSDI
HD ready
1080p

New!
System LS1601A Modules
 New RF-Over-Fiber Modules (RF/TX) and
 Digital distribution units
 Page 11



Legacy Product
Model VXI-RR161X2
 Sixteen 1x2 module (DC-3GHz)
 Page 17



New!
System MSD0601
 Dual 6x1 DC-18GHz Switcher (2RU)
 Page 11

New!
System LS1601A
 Modular "Linker System" for distribution of analog
 or digital signals with unique open window design
 Page 11



Model G2R40-71X6-60
 G2 plug-in with seven 1x6 relays (40GHz)
 Page 6 & 7



Model G2S47-6432-25
 G2 plug-in 32x32 IF matrix with expanders (20-250MHz)
 Page 6 & 7

Series G2 - CAS
 Critical Application Systems
 for IF, RF, L-Band, microwave
 and other types of signals
 Page 10

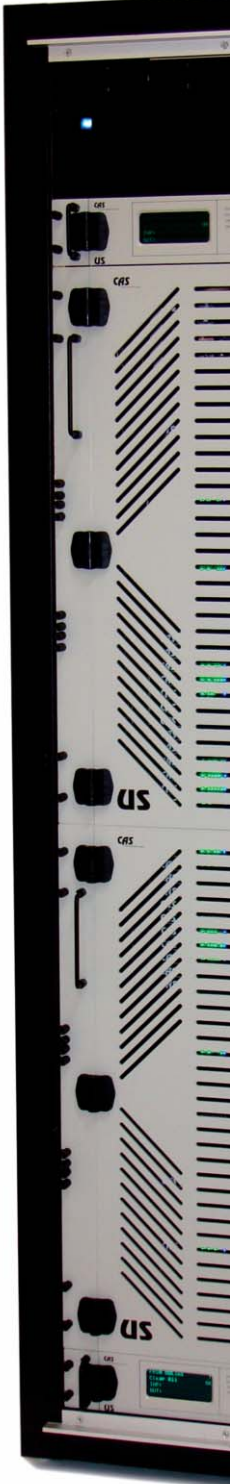

Legacy Product
Model VXI-RGB3216
RGB 16x16 200MHz video router
Page 17



New!
Model G2T4
Four-slot G2T Mainframe (2RU)
Page 6 & 7

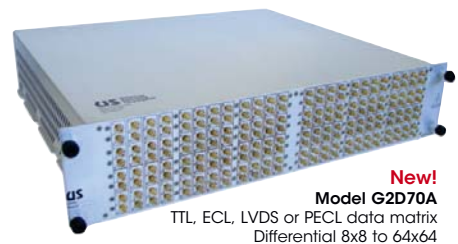

New!
Model G2D70A
TTL, ECL, LVDS or PECL data matrix
Differential 8x8 to 64x64
Page 6 & 7



Model G2R12
G2 plug-in with five high power 1x6 relays (12GHz)
Page 6 & 7



New!
Series RS70000
Rugged coaxial relays DC-800MHz
Page 14 & 15

New!
Series MDU4
Modular distribution units for
'422, TTL, ECL, LVDS, 1553, and analog
Page 10



Legacy Product
Model VXI-RMR410
Quad 10x1 (18GHz)
Page 17



New!
Model G2T16
Sixteen-slot G2 Mainframe (8RU)
Shown with dual CPUs & mixed modules installed
Page 6 & 7



New!
Series DDU32
Digital distribution unit (dual 1x32), up to 3Gbps
PECL, LVPECL, LVDS, LVTTTL distribution (clk/data)
Page 10



New!
Series HDVSU1
Low cost video routers
HD-SDI, SDI and analog
Page 10

4k HDSDi **HD ready 1080p**



New!
System S64530 and S24530A
Digital RS-530 Switching System
Modular up to 64x64 DCE/DTE (5RU)
Page 16



New!
Model RCP1
Rack mount control panel with
serial port and quad relays (1RU)
Page 8



New!
Model RM1X2
Coaxial 1x2 3GHz relay module (N-Type)
Page 8



Series G2 Rack-Mounted Modular Switching

Modules covering DC to 40GHz
Configurations from 1x2, up to 64x64

Series G2 products is our continuously evolving line of modular products. They provide the system engineer with cost effective configuration and performance options not previously available. Any Series G2 module can be installed by simply sliding the module into the rear module bay of a Series G2T Mainframe.

Solid-state, relay-based, digital and fiber-optic products are offered to meet most any requirement. The list of module types keeps growing with new products including both MxN switching arrays and 1xN types. Non-blocking (full fan-out), combining (full fan-in) and blocking arrays are available. Popular L-Band and IF switching plus fully digital types as well including TTL, E1/T1, 422, ECL, PECL and LVDS.

What is the Series G2, and how does it work?

The Series G2 is a comprehensive modular switching product design comprised of two system components. These two major system components are what's required to complete a high-performance modular switching system.

- Rack mount mainframe with hot-swap supplies and CPU
- Plug-in switching module(s)

G2T Mainframes with Touchscreen

Our rack mountable mainframes are available in four basic rack mount sizes (2RU, 3RU, 6RU and 8RU). The different sizes are offered to meet various sized switching or distribution demands from small to large. They are designed to provide control and power to any of the Series G2 plug-in modules. The modules install into the rear-facing module bay providing easy connection access for cable management (see upper right).

Hot-swap power sections in different combinations are available to meet the requirements of the various types of Series G2 modules. Supplies are self-monitoring with operational status reported to the C3 Controller. Single or redundant supplies install through hinged front panels for hot-swap replacement in critical requirements. Two supplies can be specified for redundancy with independent AC power inputs provided.

Our two larger mainframes (6RU and 8RU) can be specified to include one or two (redundant) hot-swap C3 controllers, while the smaller 3RU (G2T6) and 2RU (G2T4) can only have one. These LXI compliant CPU's provide control for the modules and also provide remote control interfacing to the user via the integrated 10/100 Ethernet, USB 2.0 and multi-serial port. Firmware is field upgradeable via the integrated web browser. For legacy applications that require GPIB, we offer our Model GPIB-USB adapter.

G2 Plug-in Modules

The modules that plug-in to our Series G2T mainframes are designed to install at the rear of the units. This makes the signal I/O connectors face the rear (inside of the rack) of the mainframe. This is best suited for most installations to simplify cable routing to and from the switching system. The Series G2 module series spans DC-40GHz to address many different applications including audio or video, high speed digital data, telemetry, IF & RF, L-Band, microwave and other types of installations. Each module occupies a certain number of module "slots" within a mainframe. Some modules occupy only one slot while others occupy up to 16 slots. Power and control for the module is supplied by the mainframe.

NOTE: Plug-in Model C3 Controller is backwards compatible for most systems, but provides new features such as a USB port, SNMP, SNTP, and IPv6. It does not include an integrated GPIB port, but our Model GPIB-USB adapter is perfect for supporting legacy applications.

Custom systems or modules are available.



Global Signal Switching and Distribution Specialists

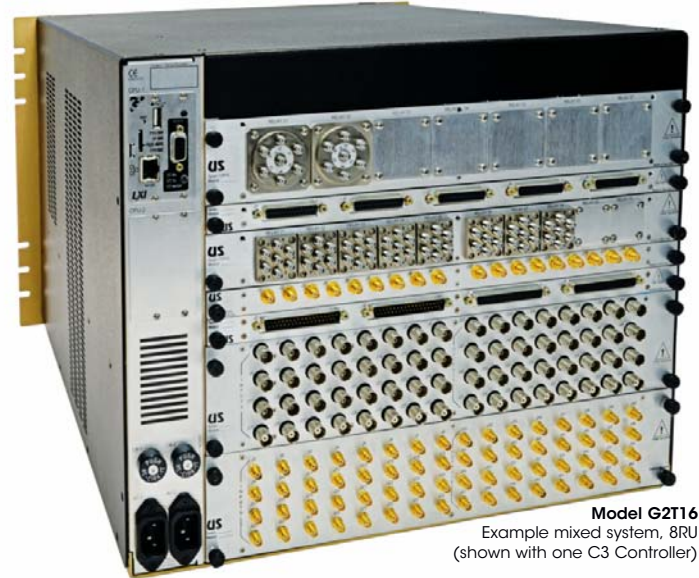

Model G2T16
Example mixed system, 8RU
(shown with one C3 Controller)



G2T4 Mainframe
Four module slots, 2RU



G2T6 Mainframe
Six module slots, 2RU



G2T12 Mainframe
Twelve module slots, 6RU
(shown with **Option X** display)



G2T16 Mainframe
Sixteen module slots, 8RU
(shown with **Option X** display)



SNMP

LXI

IPv6

C3 Controller

- Plug-in CPU
- 10/100 Ethernet, USB & Serial
- Integrated web browser
- Realtime clock
- FLASH memory
- Removable microSD card
- SNMP, SNTP, TCP/IP, IPV4, IPV6
- Look for the C3 logo



Download our Monitor & Control software **RouteWarePRO** for a FREE 30-day trial today!

Series G2 Modules: Switching Matrix Arrays - MxN (sorted by frequency range)

Series	Elements	Frequency Range	Isolation (dB) Typ	Impedance	Minimum Size	Maximum Size	Slots	Conn Type
G2S02	Solid-state	DC-500kHz	>70dB @ 100kHz	100, 300, 600 or 50K	16in, 16out	64in, 64out	1-2	D-Sub
G2R10	Relay	DC-10MHz (typ)	>45dB @ 10MHz	100 ohm balanced	4in, 4out, 2-wire	16in, 16 out, 2wire	1	D-Sub
G2S11	Solid-state	T1 & E1 rates	n/a	100 ohm balanced	8in, 8out	16in, 16out	3	RJ45
G2D62B	Digital	DC-50Mbps	n/a	100 ohm (422)	8in, 8out	64in, 64out	1-8	Triax (BJ77)
G2D64B	Digital	DC-50Mbps	n/a	100 ohm (422)	32in, 32 out	64in, 64out	1 or 2	D-Sub
G2D71	Digital	>100Mbps	LVDS in, ECL out	50 ohm (differential)	8in, 8out	64in, 64out	2-8	SMB
G2D72	Digital	>100Mbps	LVDS in, LVDS out	50 ohm (differential)	8in, 8out	64in, 64out	2-8	SMB
G2S32H	Solid-state	DC-75MHz	>60dB @ 10MHz	50 or 75 ohm	8in, 8out	64in, 64out	1-8	BNC
G2S32	Solid-state	DC-125MHz	>40dB @ 125MHz	50 or 75 ohm	8in, 8out	64in, 64out	1-8	BNC
G2S33	Solid-state	DC-160MHz	>40dB @ 125MHz	50 or 75 ohm	8in, 8out	64in, 64out	1-8	BNC
G2S44	Solid-state	20-250MHz	>60dB @ 70MHz	50 or 75 ohm	8in, 8out	48in, 48out	4-6	BNC
G2S47	Solid-state	20-250MHz	>60dB @ 70MHz	50 or 75 ohm	8in+EX, 8out+EX	48in+EX, 48out+EX	4-6	BNC
G2S48	Solid-state	20-250MHz	>60dB @ 70MHz	50 or 75 ohm	8in, 8out+EX	48in, 48out+EX	4-6	BNC
G2S54	Solid-state	20-250MHz	>60dB @ 70MHz	50 or 75 ohm (combine)	8in, 8out	48in, 48out	4-6	BNC
G2S57	Solid-state	20-250MHz	>60dB @ 70MHz	50 or 75 ohm (combine)	8in+EX, 8out+EX	48in+EX, 48out+EX	4-6	BNC
G2S58	Solid-state	20-250MHz	>60dB @ 70MHz	50 or 75 ohm (combine)	8in, 8out+EX	48in, 48out+EX	4-6	BNC
G2D70A	Digital ECL	>600Mbps	n/a	50 ohm (differential)	8in, 8out	64in, 64out	2-16	SMA or SMB
G2S42	Solid-state	20-1000MHz	>50dB @ 1000MHz	50 ohm	8in, 8out	12in, 16out	4	BNC or SMA
G2S75A	Solid-state	800-2400MHz	>50dB @ 2400MHz	50 ohm	8in, 8out	16in, 16out	4	SMA or N-Type
G2S75X	Solid-state	150-3000MHz	>50dB @ 2400MHz	50 ohm	8in, 8out	16in, 16out	4	SMA or N-Type
G2S78	Solid-state	20-3000MHz	>50dB @ 2400MHz	50 ohm	8in, 4out	16in, 16out	3-6	SMA or N-Type
G2R19A	Relay	DC-18GHz	>60dB @ 18GHz	50 ohm	4in, 2out	10in, 10out	4	SMA or N-Type

NOTE: See data sheet for full model number, specifications and suffix definitions.

Series G2 Modules: 1xN Type Arrays (sorted by frequency range)

Series	Elements	Frequency Range	Isolation (dB) Typ	Impedance	Minimum Size	Maximum Size	Slots	Conn Type
G2S08	Solid-state	DC-400Hz	Power Relay	AC or DC switch	1ea 1x1	1ea 1x8	3	Terminal Screw
G2R04	Relay	DC-10MHz (typ)	>50dB @ 10MHz	100 ohm balanced	1ea 1x4, 2-wire	1ea 1x4, 8 wire	1	D-Sub
G2R06	Relay	DC-10MHz	>60dB @ 10MHz	General purpose	8ea 1x1 (DPDT)	4ea 1x16 (DP16T)	1	D-Sub
G2R16	Relay	DC-1.3GHz	>55dB @ 1GHz	50 or 75 ohm	6ea 1x2	1ea 1x16 w/exp	1	BNC or SMA
G2R16T	Relay	DC-1.3GHz	>55dB @ 1GHz	50 or 75 ohm (self term)	6ea 1x2	1ea 1x16 w/exp	1	BNC or SMA
G2R15	Relay	DC-3GHz	>60dB @ 1GHz	50 or 75 ohm	6ea 1x2	1ea 1x16 w/exp	1	SMA
G2R15T	Relay	DC-3GHz	>60dB @ 1GHz	50 or 75 ohm (self term)	6ea 1x2	1ea 1x16 w/exp	1	SMA
G2R13	Relay	DC-6GHz	>55dB @ 3GHz	50 ohm	6ea 1x2	2ea 1x8	1	SMA
G2R20	Relay	DC-12GHz	>80dB @ 4GHz	50 ohm	1ea 1x2	6ea 1x2, 2ea 1x6	4	N-Type
G2R12	Relay	DC-12GHz	>80dB @ 4 GHz	50 ohm	1 ea 1x3	5ea 1x6	4	N-Type
G2R14	Relay	DC-18GHz	>60dB @ 18GHz	50 ohm (self terminating)	1ea 1x3	6ea 1x6	3	SMA
G2R17	Relay	DC-18GHz	>60dB @ 18GHz	50 ohm	1ea transfer	8ea transfer	2	SMA
G2R18	Relay	DC-18GHz	>60dB @ 18GHz	50 ohm	1ea 1x6	7ea 1x6	3	SMA
G2R21	Relay	DC-18GHz	>60dB @ 18GHz	50 ohm	1ea 1x2	8ea, 1x2 & transfer	2	SMA
G2R22	Relay	DC-18GHz	>60dB @ 18GHz	50 ohm	1ea 1x6	10ea 1x6	2	SMA
G2R27	Relay	DC-18GHz	>60dB @ 18GHz	50 ohm (self terminating)	1ea 1x8	4ea 1x10	5	SMA
G2R28	Relay	DC-18GHz	>60dB @ 18GHz	50 ohm	1ea 1x8	7ea 1x10	3	SMA
G2R25	Relay	DC-26.5GHz	>55dB @ 26GHz	50 ohm	4ea 1x2	16ea 1x2	2	SMA
G2R40	Relay	DC-40GHz	>50dB @ 40GHz	50 ohm	1ea 1x3	7ea 1x6	3	K-Type
G2F90	Mems	1300-1610nm	>50dB	n/a	1ea 1x2	8ea 1x2	2	SC or FC

NOTE: See data sheet for full model number, specifications and suffix definitions.

Modular L-Band Switching System Available Q2-2017 System SLX320/SLX320i

Flexible configurations from 8x8 to 64x256: 850-2450MHz

Designed to be the "gold standard" for large format L-Band, S-Band, and IF matrices, our new SLX320(i) Tri-Stage product is rich with features. Leveraging the absolute latest in component technology and design concepts, these modular switch arrays are specifically designed for routing high performance signals in asymmetric matrix configurations. They provide respectable crosstalk isolation, noise figure, IP3 and other critical analog parameters.

The SLX320 provides a modular configuration up to 64in x 256out in 8-channel port expansion increments to either the input or output. The SLX320 is a Fan-OUT unit (multiple outputs can connect from a given input source).

Our complementary SLX320i is a Fan-IN unit (combine multiple inputs to a given output) and similarly provides a modular configuration up to 256in x 64out in 8-channel port expansion.

Units come standard with redundant hot-swap power supplies, and can feature either one or two hot-swappable plug-in control CPUs. An extension of our CAS product line, all active modules, power supplies and assemblies are installed via the lockable hinged front panel. No rear panel access is needed to maintain the unit.

Our popular RouteWarePRO software package (included) makes it easy to control multiple units from the same GUI, or you can manage the unit from a web browser window. Our critical new "X-Point Classing" feature is included. Custom configurations are simple for the factory to provide upon request. Contact the factory or your local sales person.

System Type	Frequency Range	Features
SLX320	950-2150MHz	Standard range, non-blocking Fan-OUT
SLX320i	950-2150MHz	Standard range, combiner Fan-IN
SLX321	850-2450MHz	Extended range, non-blocking Fan-OUT
SLX321i	850-2450MHz	Extended range, combiner Fan-IN
SLX320P	Call Factory	Wide range, non-blocking Fan-OUT

NOTE: See data sheet for full model number, specifications and suffix definitions.



Download our Monitor & Control software **RouteWarePRO** for a FREE 30-day trial today!

- Applications:**
- Communications
 - Teleport and last mile
 - Encryption Tx/Rx modem
 - Satellite ground stations
 - ENG vans or trucks
 - Uplinks or downlinks



System SLX320 L-Band System
Modular configurations up to 64x256 (13RU)



Coaxial Relay Modules: DC-3GHz Model RM1X2

Cascadeable module, optional control panels: DC-3GHz

The RM1X2 is a high performance low cost coaxial relay module with N-Type connectors that can be used by itself, or mounted to a choice of two 1RU rack mount relay control panels. The relay has a DE-9P connector with a DE-9S on the opposite side of the module so that one module can plug into another. Relay control lines are passed through the module and kept independent so up to four relays can be either ganged controlled or independent depending upon requirements.

The 1RU sized RCP1 and RCP1R rack mount control panels include an integrated serial control port and relay drivers. The RCP1R unit is designed for the relay connectors to face inside the rack, and the RCP1 is designed so everything faces the front of the rack (see below). They can DC powered, or include an optional wall mount power supply.



- Applications:**
- Redundancy
 - Teleport and last mile
 - Backup antennas
 - Satellite ground stations
 - Communications
 - Uplinks or downlinks



Model	Description
RM1X2	Relay module DC-3GHz, N-Type normally open
RM1X2T	Relay module DC-3GHz, N-Type self terminating (50 ohms)
RCP1	1RU Relay control panel, everything faces front of rack
RCP1R	1RU Relay control panel, everything faces rear of rack

NOTE: See data sheet for model number suffix definitions for DC voltages and AC wall mount power options.



Global Signal Switching and Distribution Specialists

Modular IF, L-Band, S-Band Switching System System SxM32 & SxM32i

Flexible configurations from 4x4 to 32x32: 20MHz-4GHz

Eliminating multi-couplers, manual patch bays and patch cords, the System SxM32 is a solid-state modular switch array specifically designed for routing of signals with very respectable crosstalk isolation, noise figure, IP3, and other critical analog parameters. It can be configured in single-channel increments up to 32x32.

Fully populated, the unit provides 32 input ports and 32 output ports in a modular 6RU package. The SxM32 is a Fan-Out unit (multiple outputs can connect to a given input), and the SxM32i is a Fan-In unit (combine multiple inputs to a given output). In the table below are some standard frequency ranges available spanning 20MHz to 4GHz.

This unit is configurable from as small as 4x4 to 32x32 in independent increments of one input channel or one output channel. Our unique design allows isolated failure capability. Should a card receive a damaging signal or have a failure, it will only affect that individual channel and not a group of channels.

Typically the input cards install at the rear, and output cards install at the front (behind the hinged front panel). All cards and modules are secured within the unit for rugged and trouble free operation.

The front panel includes a touchscreen display with menu driven operation. You can pick between the standard 4.3" display, or the **Option X** display (shown to the right) which provides many more features. The unit can be configured with single or dual power supplies and CPU's (full redundant). An additional dual LNB power supply can be installed as well if needed for antenna installations.

Applications:

- Communications
- Teleport and last mile
- Encryption Tx/Rx modem
- Satellite ground stations
- Security installations
- Uplinks or downlinks

New!



System SLM32 L-Band System
Modular configurations up to 32x32
(shown with **Option X** display - 6RU)

System Type	Frequency Range	Features
SLM32	950-2150MHz	Standard range, non-blocking Fan-OUT
SLM32i	950-2150MHz	Standard range, combiner Fan-IN
SLM32 opt1	850-2450MHz	Extended range, non-blocking Fan-OUT
SLM32i opt1	850-2450MHz	Extended range, combiner Fan-IN
SLM32P	Call Factory	Wide range, non-blocking Fan-OUT

NOTE: See data sheet for full model number, specifications and suffix definitions.



Download our Monitor & Control software **RouteWarePRO** for a FREE 30-day trial today!



L-Band & IF Fixed-Sized Switching System SLM16: 850-2450MHz System SIM16: 25-250MHz

For budget minded yet performance demanding applications like ENG vans or trucks, these 1RU units are purpose built for IF and L-Band switching. Boasting 16 inputs and 16 outputs, these units provide a very cost effective solution. Though only available in 8x8 or 16x16, and SMA or BNC connectors, the SLM16 and SIM16 provide great specifications for IP3, noise figure and isolation.

The 1RU high units come standard with 10/100 Ethernet control port, web browser (SNMP/IPv6/LXI), and optional redundant power supplies. Signal connectors are located at the rear, and a front panel LCD display and local is included. As a promotion during 2017, each unit comes with one license of RouteWarePRO 5.0 included.

NOTE: See data sheet for full model number, specifications and suffix definitions.

Applications:

- Communications
- Teleport and last mile
- Encryption Tx/Rx modem
- Satellite ground stations
- ENG vans or trucks
- Uplinks or downlinks



Free copy of our monitor & control software **RouteWarePRO** with each SLM16 or SIM16 unit in 2017

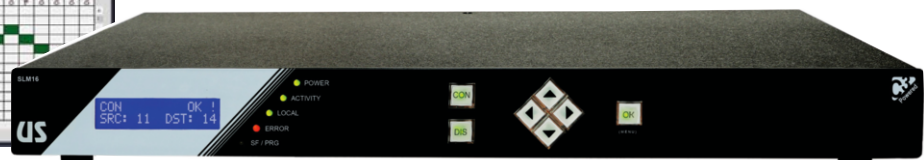
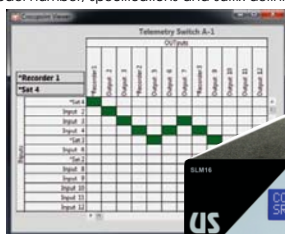

Global Signal Switching and Distribution Specialists

NEW!
System SLM16
16 x 16 L-Band Matrix



Series G2 - CAS (Critical Application System)

Modules covering DC to 30GHz - Digital or Analog
Rack Mounted Modular Switching Configurations

The CAS version of our field proven Series G2 products brings switching system technology to a new level. Derived from our Series G2, the CAS version is specifically designed for ease of maintenance and high reliability coupled with a streamlined rugged design.

The typical CAS configuration consists of a 2RU power and control head, plus one or more switch frames depending upon the overall system configuration. The 2RU head unit can be configured with front loading dual hot-swap power supplies and dual hot-swap control CPU's. Standard features include touchscreen controls. The switch frames are available in standard sizes to meet common system needs. The frames are easily configured to user needs providing all interconnect cabling required between the front loading CAS modules and the rear connector panels. Rear panel signal connectors can be specified to meet any user requirement.

All modules, CPU's and power supplies can be hot-swapped via the hinged front panels without disturbing any cabling whatsoever. Simply open the front panel, slide an item out and replace with a spare.

Applications:

- Ground stations
- Communication centers
- Defense or FAA needs
- Critical missions



Series G2 - CAS
Example front view, 7RU



Series G2 - CAS
Example 17RU rear view



Series G2 - CAS
2RU control and power unit



Series G2 - CAS
Example CAS switch frame, 17RU

Video Routers and Distribution Systems

4KSDI, HD-SDI, SDI and Analog Video Routers & Distribution Units

Specifically designed for analog and digital video switching or distribution, these units provide an effective solution for smaller video installations. Compact and feature loaded, they are only 1RU or 2RU high and turn-key out of the box. These "fixed" configurations systems are not modular to reduce their cost. Suffix dash numbers can define other options. Units include 10/100 Ethernet control ports and web browser.

Model	Frequency Range	Features
VSU1-3208 (H)	DC-300MHz	24in, 8out analog, 75 ohm
VSU1-3216 (H)	DC-300MHz	16in, 16out analog, 75 ohm
VSU1-3224 (H)	DC-300MHz	8in, 24out analog, 75 ohm
HDVSU1-3216	270M/1.485G/2.97G	16in, 16out digital (SMPTE 292M, 424M)
VSU1-4P6T	DC-135MHz	Quad 6x1analog, high level
VSU1-4P6T-AB	DC-135MHz	Quad 6x1analog, high level with A/B
HDVSU2-6432	270M/1.485G/2.97G	32in, 32out digital (SMPTE 292M, 424M)
VSU2-6432	DC-500MHz	32in, 32out analog, 75 ohm
VDU1-408-R	DC-125MHz	Quad 1x8 distribution amplifier, 75 ohm
DDU32-xxxx	Up to 3Gbps	Dual 1x32 digital distribution

NOTE: See data sheet for full model number, specifications and suffix definitions.



NEW! Model HDVSU1-3216
16 input, 16 output
(shown without mounting flanges installed)



Download our Monitor & Control software **RouteWarePRO** for a FREE 30-day trial today!

Applications:

- SDI, HD-SDI, 4K-SDI Video
- NTSC and RGB Video
- DVI-D and HDMI
- TTL or IRIG Timecode

4K HDSdi

HD ready 1080p



New!
Series HDVMU1
Low cost SDI video muxes
4Ksdi HDsdi, SDI & NTSC (1RU)



New!
Model DDU32
Dual 1x32 Digital Distribution
PECL, LVPECL, LVTTL, LVDS



Model VDU1-408-R
Quad 1x8 Distribution Amplifier
with redundant power supplies

NOTES:

1. Other versions available as well.
2. The "H" option on the VSU1 allows +/-5V signals and up to 75MHz bandpass (35MHz @ +/-5V)
3. The VDU1-408-R is available with 1-4 sections.



System HDVSU2
32 input, 32 output
(similar unit shown)



US Corporation

Global Signal Switching and Distribution Specialists

Signal Distribution, Conversion, Switching

Linker System LS1601A - Up to Sixteen Modules

Many times there is a need to convert various signal types, buffer them or even provide distribution or switching for these signals. Our "Linker System" provides a very cost effective means to provide all these functions. Properly configured with the appropriate modules it can be a "drop-in" replacement for many units from APCOM or Apogee Labs (and other companies), but with additional capability, features, higher quality, and newer technology.

The 3RU high LS1601A provides the system professional with an uncompromising combination of modularity, high performance and high reliability. The unique design provides sixteen module slots where any combination of modules can be installed from the rear of the unit and (depending upon the module type) can also provide front panel indicators, adjustments and test points to the user. Modules typically have the signal connectors at the rear.

The unit's modules are hot-swap design and the frame can be populated with redundant hot-swap power supplies to deliver the ultimate in system reliability for critical applications.

A number of digital, analog and RF-Over-Fiber modules are available and can be mixed and matched within the same frame. Each slot is addressable so that the user can monitor or control an individual module independent of another with the optional plug-in C3-LS16 Controller with Ethernet port. The LXI certified CPU provides the user with web browser control and TCP/IP access to remotely monitor and control the system including power supplies, fans and unit health. Customized modules are available.

NOTE: See data sheet for full model number, specifications and suffix definitions.



Applications:

- PCM Telemetry
- TTL Clock and Data
- Mixed analog signals
- 422 Clock and Data
- IRIG time code
- Audio or Video routing
- Digital conversion



New!
LS1601A showing the "Open Window" front panel design



Model	Description
LS1601A	Empty chassis frame (without power supplies, CPU or modules)
PLS01-150	Plug-in power supply module (150 Watt)
C3-LS16	Plug-in Monitor and Control CPU with 10/100 LXI

Model	Frequency Range	Module Description
LS16-A07	DC-40MHz	Distribution Module: 1x6 analog video distribution, gain adjustments and detectors, BNC
LS16-D05	40Mbps	Distribution Module: 1x6 digital distribution and converter, 422 (3) and TTL (3), Triax and BNC
New! LS16-D09	40Mbps	Distribution Module: Dual 1x2 TTL digital distribution, 50/75 or High Z input, BNC
LS16-S04	DC-3GHz	Switch Module: 1x6 relay mux with user config input termination, BNC
New! LS16-F12	50MHz-3GHz	RF Over Fiber (Rx and Tx), dual or single channel, LNB power optional
New! LS16-S06-x	DC-18GHz	Switch Module: up to three 2x1 relay elements, SMA

Microwave DC-18GHz Switchers System MSD0601, MS06X02 and MS2010A

These purpose built units provide a cost effective solution. The MSD0601 provides the user with two individual 6x1 self-terminating DC-18GHz switch paths, plus an A/B output selector. The MS06X02 is a blocking (no fanout) bidirectional 6x2 matrix. The new MS2010A can be configured from 4x4 to 12x12 (shown to the right).

These 2RU high units provide the system designer with an uncompromising combination of functionality, high performance and high reliability. Some offer all signal connectors at the front panel, plus an intuitive LED illuminated pushbutton adjacent to each port. Designed in is an LXI Ethernet port (10/100) for simple control of the unit. Can be ordered with connectors on front or rear.

NOTE: See data sheets for full model number, specifications and suffix definitions.



Download our Monitor & Control software **RouteWarePRO** for a FREE 30-day trial today!

Applications:

- Telemetry routing
- Antenna Selection
- Mixed analog signals
- High speed data
- ATE selector or router



NEW!
System MS2010A
Modular 18GHz Matrix
Up to 12x12 (10x10 shown)
Low MTTR



System MS06X02
Blocking 6x2 matrix
(connectors available front or rear)



System MSD0601
Dual 6x1 with A/B



Global Signal Switching and Distribution Specialists



Flexible Digital & Analog Systems System S256xF (S256xF)

Flexible configurations from 32x32 to 1024x1024: DC-125MHz

High performance and cost effective switching arrays are available in a COTS solution with the S256xF switching systems. These units may be configured up to a 256 input x 256 output system in a single chassis. With four units, a 512x512 can easily be configured, or sixteen units for a huge 1024x1024. They offer the highest crosspoint density in the switching industry with over 65,500 effective cross-points in a single 5RU (8.75" high) rack mount package.

As many as eight input modules (left side) and eight output modules (right side) may be installed. Each module adds 32 channels to the system capacity. The system is sized by installing the desired number of hot-swap plug-in modules to size the configuration.

Built-in redundant signal paths allow each I/O connection up to 30 different signal paths for ultimate reliability. The solid-state digital or analog cores offer high bandwidth and performance. The input and output modules are available with a number of different input and output specifications. Modules are available for digital 422, analog, and instrumentation. These can be mated to compatible Series AP adapter panels to allow for different type of signal connectivity (422, TTL, or analog) for a truly comprehensive solution.

Our newly updated "FX" types include our **Option X** display which is a 10.1" touchscreen with X-Point views and other enhanced features. The "F" version is the same but has a smaller 4.3" touchscreen without X-Point viewing. These units also include our C3 plug-in CPU (single or dual) with web browser interface, 10/100 Ethernet, USB 2.0, multi-serial ports, and also includes an important new feature called "X-Point classing".

The example shown below illustrates the S2561F used as a building block to configure a full 512 input, 512 output configuration with over 125MHz bandpass capability using the external 1RU adapter panel assemblies (Series AP32x).

System Type	Frequency Range	Features
S2560FX	>50Mbps	Differential digital (422) I/O, SCSI-II
S2561FX	DC-125MHz	Single-ended analog, 50 Position D-Sub
S2562FX	DC-200kHz	Single-ended instrumentation analog
S2566FX	Hybrid	Both digital and analog types

NOTE: See data sheet for full model number, specifications and suffix definitions.



Download our Monitor & Control software **RouteWarePRO** for a FREE 30-day trial today!

Applications:

- PCM Telemetry
- TTL Clock and Data
- Mixed analog signals
- 422 Clock and Data
- IRIG time code

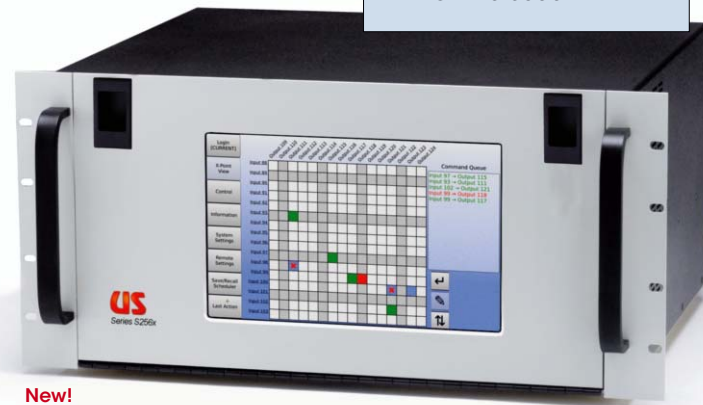

New!
System S256xF (5RU)
(shown with Option X display)



System S256xF (5RU)
4.3" Screen



Series AP32 Adapter Panels
Units available for various configurations with interconnect cables included



System S2561F Example

Configured as a 512x512:
Four S2561F Units
Sixteen input panels
Sixteen output panels



Pre-Configured TS2 Systems

This convenient system package called "TS2" which takes common configurations from our Series G2 switching line (see pages 6 & 7) and makes it simple to order a completely "turn-key" unit. All units are based on the 2RU rack mounted G2T4 unit, include redundant power supplies and contain all three remote interface types (10/00 Ethernet, Serial and USB).

The "TS2" supplants the "SS2" units. It incorporates our advanced C3 Controller and touchscreen display. See our website for additional details and individual data sheets.



Download our Monitor & Control software **RouteWarePRO** for a FREE 30-day trial today!



New!
TS2 Pre-Configured Systems

Model	Frequency Range	Configuration
TS202	DC-150Khz	Differential analog matrix for audio or telemetry, 16x16 to 64x64
TS214	DC-18GHz	Up to six 6x1 self-terminating microwave relays
TS215	DC-3GHz	Coaxial Nx1 switching, 2x1, 4x1, 8x1, 16x1 sizes, SMA connectors
TS216	DC-1.3GHz	Coaxial Nx1 switching, 2x1, 4x1, 8x1, 16x1 sizes, BNC or SMA
TS216T	DC-1.3GHz	Coaxial Nx1 switching with self-termination, 2x1, 4x1, 8x1, 16x1 sizes, BNC or SMA
TS218	DC-18GHz	Up to seven 6x1 normally open microwave relays, SMA connectors
TS232	DC-125MHz	DC coupled system for high frequency video signals (+/- 1.5V)
TS232H	DC-75MHz	DC coupled system for high-level PCM, video, TTL or similar signals (+/-5V)
TS240	DC-40GHz	Up to seven 6x1 normally open microwave relays, SMA connectors
TS244	20-250MHz	High performance non-blocking "fan out" IF matrix, 8x8 to 32x32, 50 or 75 ohm
TS254	20-250MHz	High performance combining "fan in" IF matrix, 8x8 to 32x32, 50 or 75 ohm
TS264B	DC-50Mbps	Differential 422 digital matrix for clock/data, 16x16 to 64x64, single or dual

NOTE: See data sheet for full model number, specifications and suffix definitions.



Redundancy Switching (backup) System RSX4

Modular with Single, Dual or Quad Channels

High value satellite communication assets require high reliability equipment. Our all new RSX4 is designed to be a drop-in replacement for our field proven 1094xB units in control, capability and performance. Standard features include front panel display, manual buttons, redundant power supplies and is available in AC or AC/DC powered versions. It is designed as the "gold standard" in system reliability for critical SatCom applications.

The unit consists of an RSX4 "universal chassis" that features two rear facing slots. Slots (one or both) can be populated by a choice of redundancy function modules and easily reconfigured in the field as needs change.

Applications:

- Communication centers
- Signal redundancy
- L-Band, IF, RF signals
- Satellite systems
- ENG vans or trucks

New!
System RSX4
Universal Redundancy Chassis

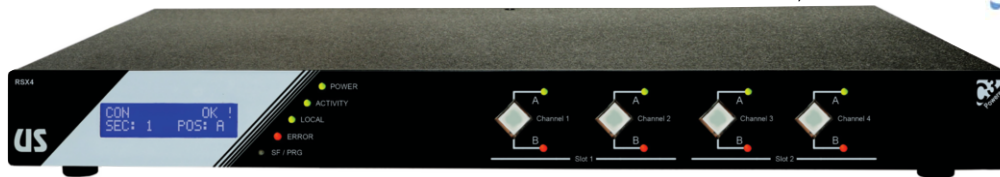

Module Type	Frequency Range	Features
XRSX4-R001-25C	DC-900MHz	Two 2x1 relays, BNC connectors, 50 ohm
XRSX4-R001-27C	DC-900MHz	Two 2x1 relays, BNC connectors, 75 ohm
XRSX4-R003-25A	DC-3GHz	Two 2x1 relays, SMA connectors, 50 ohm
XRSX4-R004-25A	DC-6GHz	Two transfer relays, SMA connectors, 50 ohm
XRSX4-R005-25A	DC-18GHz	Two transfer relays, SMA connectors, 50 ohm

NOTE: See data sheet for full model number, specifications and suffix definitions.



Legacy Product
Model 10942B
DC-800MHz



Global Signal Switching and Distribution Specialists



Series 70000 and RS70000 Coaxial Relays

Rugged Coaxial Relays: DC-800MHz (frequency is size dependent)
Sizes from 2x1 to 24x1

USC acquired the product line of Matrix Systems Corporation in April of 2007. One of the product lines that USC continues to build is the unique coaxial relay line. The 70000 and RS70000 relays are unique in the relay industry due to the rugged design and excellent shielding characteristics.

The Series 70000 is an Nx1 relay with various coaxial contact types controlled by DC voltage. The Series RS70000 is also an Nx1 relay (like the Series 70000), but has a built-in serial control port as well. The RS70000 can be used in a standalone installation since the control port and wall mount style power supply is included.

The Series 70000 relay is used by simply applying the appropriate DC voltages, or install it into a Model U11600 rack mount chassis complete with relay drivers, remote control ports and power supplies as shown below. It has an LCD display and can be populated with up to 24 relay modules. LED illuminated driver cards must be installed for each relay installed. Status of the relays can be viewed through the top of the chassis.

USC has slightly changed the model numbering of the original series for compatibility with our inventory system. If you are unsure what your new model number might be, feel free to contact our application staff for assistance. Note that not all combinations or sizes are being built. For exact reorder of an old MSC unit, there will be a minimum order quantity of five. Contact your local salesperson or the factory for details.

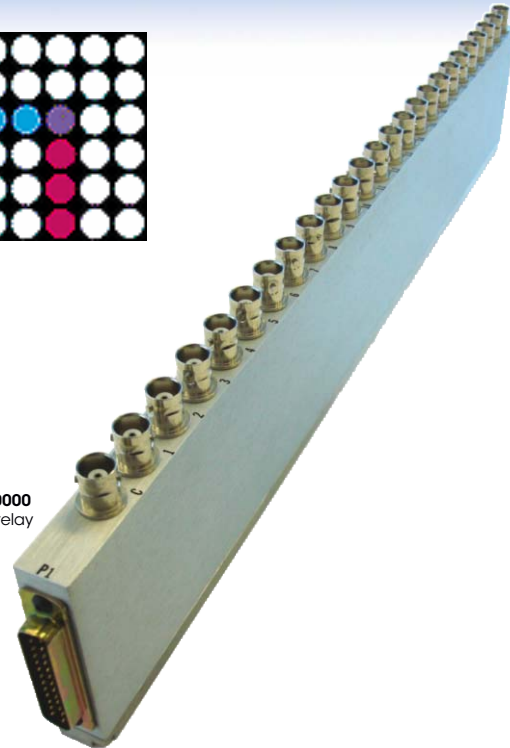
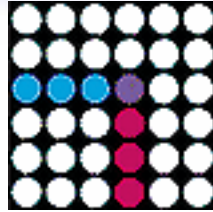

Series 70000
Coaxial relay



Series RS70000
Coaxial relay with serial port and wall mount power supply



Model U11600-26
Rack mount relay chassis with power supply, GPIB and RS-232C port

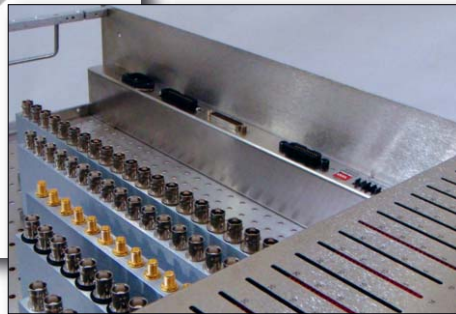
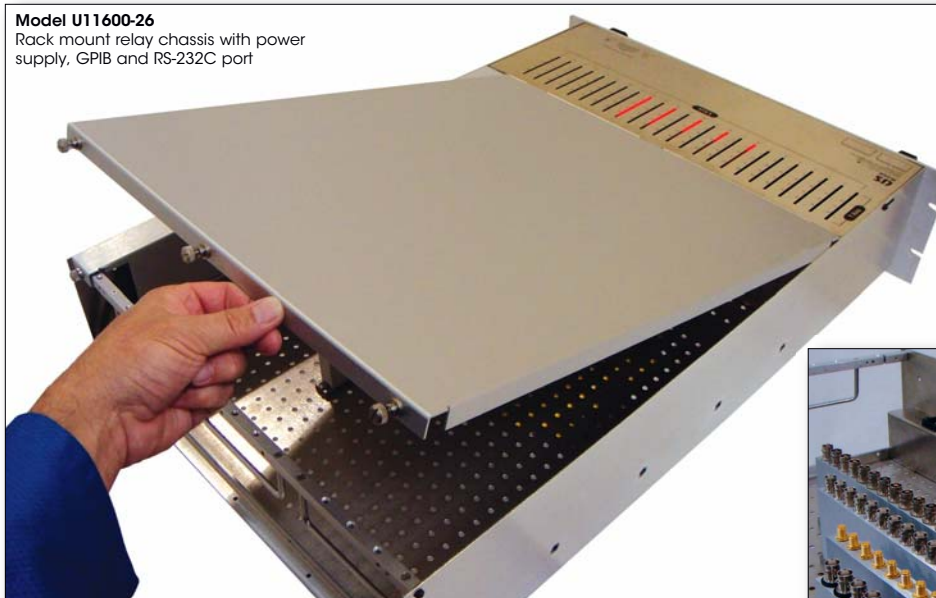

Loss vs Frequency

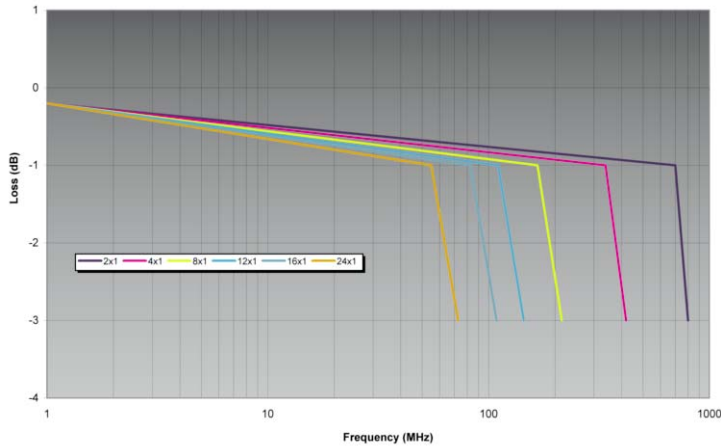

Isolation vs Frequency

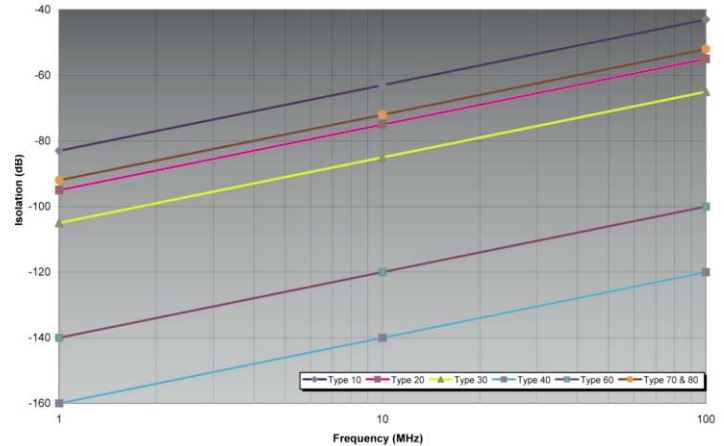

70000 Model Number Definition

U7[CC][NT]-[V][D][X]

Example: U72512-1PA (contact 25, 12x1, 24vdc, diodes with common positive and SMA's)

[CC] - Contact Configuration Type

- 10 - Standard (normally open) 100vdc, 250ma, 10W
- 25 - Standard (self-terminating type, 50 ohm) 4vdc, 250ma, 1/3W
- 27 - Standard (self-terminating type, 75 ohm) 4vdc, 250ma, 1/3W
- 30 - Medium isolation (normally open) 100vdc, 250ma, 10W
- 40 - High isolation (normally open) 28vdc, 250ma, 3W
- 65 - High isolation (self-terminating, 50 ohm) 4vdc, 250ma, 1/3W
- 67 - High isolation (self-terminating, 75 ohm) 4vdc, 250ma, 1/3W
- 70 - Mercury wetted (normally open) 500vdc, 1A, 35W (Note 5)
- 90 - Standard with Triaxial connector (BJ77) 100vdc, 250ma, 10W

[NT] - Number of throws

- 02 - 2x1
- 04 - 4x1
- 08 - 8x1
- 12 - 12x1
- 16 - 16x1
- 24 - 24x1

[V] - Coil voltage (nominal)

- 1 - 24vdc to 28vdc (1000 ohm coils)
- 2 - 15vdc (500 ohm coils)
- 5 - 5vdc (135 ohm coils with NO series polarity diode included: P or N option)

[D] - Coil suppression diodes

- 0 - Not included
- P - Suppression diodes included with coil common positive
- N - Suppression diodes included with coil common negative

[X] - Extra options

- A - SMA signal connectors (only on contact types 10, 25, 27 & 65)
- F - F-Type signal connectors (only on contact types 10, 27)
- T - TNC signal connectors (only on contact types 10, 25, & 65)
- I - Insulated coaxial shield (only on contact types 10, 25, 27 & 70)
- S - Insulated & switched coaxial shield (only contact types 10, 25, 27, 70)
- L - Lockscrews on control connector so mate can be secured

U70000 NOTES:

1. The I or S options are not available on the optional signal connectors or the contact type 90 (triaxial).
2. The "expander" port is not available any longer.
3. No mating connectors or hardware are included.
4. Contact type 70 must be mounted with signal connectors facing up.
5. Due to new environmental laws, USC may or may not be able to sell relays with mercury wetted contacts. Spec was 2A, 50W. Connectors must be within 20 deg of up.
6. For installing into the U11600 chassis, the "-1" coil voltage is needed.
7. Type 27 and 67 use the standard 50 ohm MSC connector.

RS70000 Model Number Definition

URS7[CC][NT]-[X]

Example: URS71008-A (contact 10, 8x1, and SMA connectors)

[CC] - Contact Configuration

- 10 - Standard (normally open) 100vdc, 250ma, 10W
- 25 - Standard (self-terminating type, 50 ohm) 4vdc, 250ma, 1/3W
- 27 - Standard (self-terminating type, 75 ohm) 4vdc, 250ma, 1/3W
- 30 - Medium isolation (normally open) 100vdc, 250ma, 10W
- 40 - High isolation (normally open) 28vdc, 250ma, 3W
- 65 - High isolation (self-terminating, 50 ohm) 4vdc, 250ma, 1/3W
- 67 - High isolation (self-terminating, 75 ohm) 4vdc, 250ma, 1/3W
- 70 - Mercury wetted (normally open) 500vdc, 1A, 35W (Note 5)
- 90 - Standard with Triaxial connector (BJ77) 100vdc, 250ma, 10W

[NT] - Number of throws

- 02 - 2x1
- 04 - 4x1
- 08 - 8x1
- 12 - 12x1
- 16 - 16x1
- 24 - 24x1

[X] - Extra options

- A - SMA signal connectors (only on contact types 10, 25, 27 & 65)
- F - F-Type signal connectors (only on contact types 10, 27)
- T - TNC signal connectors (only on contact types 10, 25, & 65)
- I - Insulated coaxial shield (only on contact types 10, 25, 27 & 70)
- S - Insulated & switched coaxial shield (only contact types 10, 25, 27, 70)

URS70000 NOTES:

1. The I or S options are not available on the optional signal connectors or the contact type 90 (triaxial).
2. The "expander" port is not available any longer.
3. No mating connectors or hardware are included.
4. Contact type 70 must be mounted with signal connectors facing up.
5. Due to new environmental laws, USC may or may not be able to sell relays with mercury wetted contacts. Spec used to be 2A, 50W.
7. Type 27 and 67 use the standard 50 ohm MSC connector.

Multi-Level Digital Routing - RS530

System S24530A(X) & S64530(X)

Flexible configurations from 3x3 to 64x64: Up to 50Mbps

System S24530A and S64350 are digital switch arrays specifically designed for routing RS-530 signals. **Adding an "X" to the system number adds a 10.1" display and active X-Point control features.** Fully populated, the S24530A contains 24 DTE ports that can be connected to 24 DCE ports (and the S64530 and be populated to 64x64). All RS-530 signals are routed on the DB25 connectors. The unit is configurable from 3x3 to 24x24 in independent (DCE, DTE) increments of three ports. The S64530 has 2.5 times the number of ports (64x64) and utilizes adapter panels for connectivity while still in a 5RU package (see bottom of page).

The 5RU rack mountable unit can be populated with up to eight DCE modules and eight DTE modules, each containing 3-ports (or 6 ports for the S64530). These modules install at the rear of the unit with the ports rear facing.

All modules are secured to the unit with stainless hardware for rugged and trouble free operation. For smaller configurations, filler plates for the rear complete the user configuration.

The unit may be configured with one or two C3 Controllers providing 10/100 Ethernet with web browser, USB port, and multi-serial. Two self-monitoring hot-swap plug-in power supplies can be powered by any international AC power source. Customized configurations are available.

NOTE: See data sheets for full model number, specifications and suffix definitions.

Applications:

- TDMA Satellite Control
- FDMA Control
- TTL Clock and Data
- CDMA Satellite Control
- 422 Clock and Data

System S24530A
RS-530 Digital System
24X24

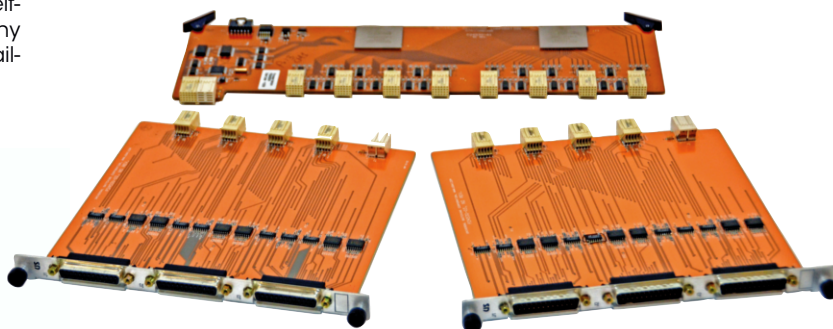
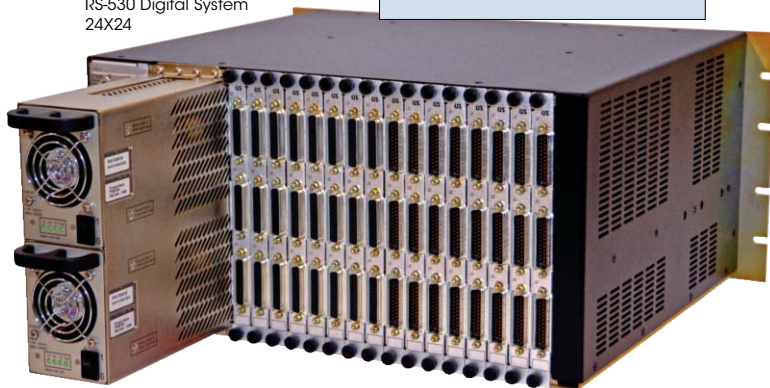

New!
System S64530X (5RU)
10.1" Screen



4.3" Screen



Download our Monitor & Control software **RouteWarePRO** for a FREE 30-day trial today!

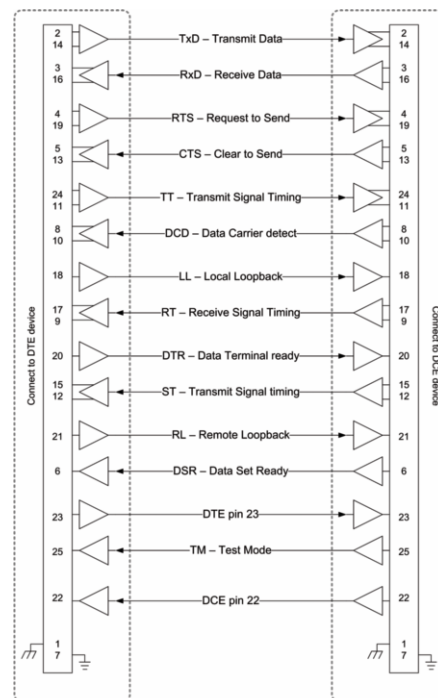

This diagram is to clarify the directionality and function of the signals that will be switched.

New!
System S64530
RS-530 Digital System
64X64 with Adapter Panels



VXIbus Switching Modules (Legacy Product)

Register-based VXIbus modules for ATE and Avionics

Our version 1.4 VXIbus modules are designed for a number of switching applications including ATE, video, digital signals and microwave. Sizes are C1 to C5.

Model	Size	Configuration Description
VXI-AS4816	C1	32x16 two wire analog switching array (DC-150kHz)
VXI-D4816	C1	32x16 digital data switching array ('422 type)
VXI-RR161X2	C1	Sixteen 2x1 relay sections with SMB connectors (DC-1.3GHz)
VXI-RRQ8	C1	Four 8x1 relay sections with SMB connectors (DC-1.3GHz)
VXI-RMR46	C2	Quad 1x6 relay sections (DC-18GHz, 26GHz, or 40GHz)
VXI-RMR410	C2	Quad 1x10 relay sections (DC-18GHz)
VXI-RMR107	C5	Mixed relay sections (DC-18GHz and 40GHz)
VXI-RMR76	C1	Seven 1x6 relay sections, DC-18GHz
VXI-RMR242B	C2	Twenty-four 1x2 relay sections (DC-26GHz)
VXI-E3216	C2	16x16 differential ECL array (PECL or LVDS available too)
VXI-RGB3216	C1	RGB non-blocking full fanout video matrix (DC-200MHz)

VXI-RM1
Ruggedized Mainframe



VXI-DS4816



VXI-RGB3216



VXI-RR161X2



VXI-RMR410



VXI-RMR107

Control & Monitor Software

RouteWarePRO 5.0

Connect to 1, 2 or up to 100+ units: Individual license, or 5-pack

Our product called RouteWarePRO is a self-contained GUI software package designed specifically to control and monitor Universal Switching Corporation's products. Engineered for ease of use, most users are up and running within minutes. Download our Monitor & Control software **RouteWarePRO** for a FREE 30-day trial today!

GUI colors, channel labeling and configuration uploads are all user definable.

Version 5.0 improvements:

- Updated Metro visual style and improved functionality
- Improved X-Point grid features
 - * Touchscreen friendly grid size
 - * Subset assignments and view to simplify navigating large matrices
 - * Lockout/Summary view for status-only display
- Fully updated for Windows 10/8.1/8/7 compatibility
- Class assignment/editor for creating connection restrictions
- Direct support for C3 generation CPU functions
 - * Class assignment and management
 - * Names/Labels (Port, Memory Location, and Class)
 - * Event Scheduler & Device Log
 - * Time stamped memory locations & Device Log
- Signal activity status indicators (on supported hardware)
- Tr-Stage diagnostics (exemption table and active scan support)



Release Date: Q1-2017
(Beta testing available)

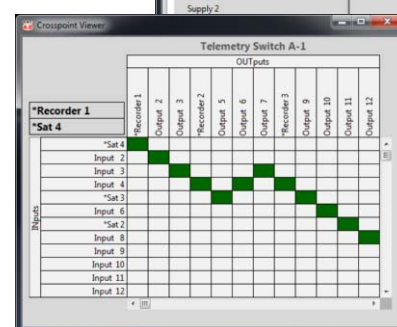
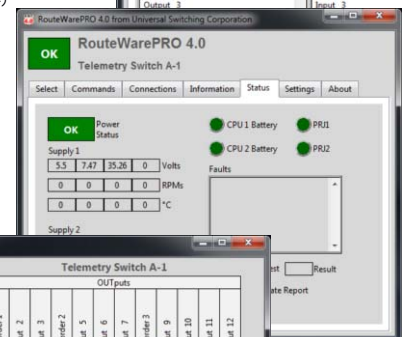
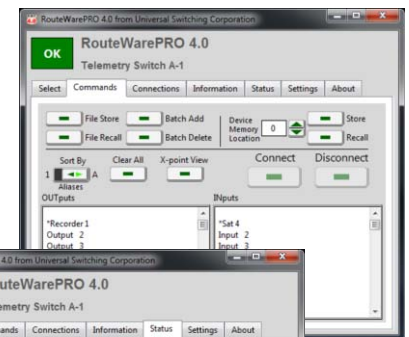

Global Signal Switching and Distribution Specialists



Take Control of Your Requirements

Controllers, Adapters and Interfaces

Universal Switching Corporation can provide the complete solution to your switching needs including remote control and status panels, rack-mounted control PC units, plus monitor and control software. All units are designed to be remotely controlled. We offer many choices including 10/100 Ethernet, Serial (RS-232C, RS-422A & RS-485), USB 2.0, GPIB and manual.



Series RCPA
Remote Control Panel
Assemblies



C3 Controller CPU
Hot-swappable, plug-in controller with 10/100 Ethernet, USB & Serial ports, plus microSD memory slot



Download our Monitor & Control software **RouteWarePRO** for a FREE 30-day trial today!



Model GPIB-USB
GPIB adapter for GPIB controlled legacy products

Quality Management System

Since 2007, Universal Switching Corporation has implemented and maintains a Quality Management System (QMS) which serves as the backbone for the products, services and innovative designs offered. Continuing our commitment to being the leader in the programmable switching industry, the company is certified to the ISO 9001:2008 quality standard.

Universal Switching Corporation's management fully supports the ISO process and its function within the company. The tremendous teamwork and dedication shown by all "Team USC" members to our Quality Management System has resulted in continuous re-certification by National Quality Assurance since our QMS was effected. Of all QMS regimes, the ISO 9000 family of standards is probably the most widely implemented across the global.

Quality Policy

Universal Switching Corporation is committed to being the leader in the programmable switching industry by providing innovative products and services that continually exceed our customer expectations.

Quality Statement

Universal Switching Corporation has a Quality Policy that serves as the backbone for the products, services and innovative designs it offers. As a global supplier of cutting-edge switching equipment and associated support products, Universal Switching Corporation's management fully supports the ISO process and its function within the company. In achieving ISO 9001:2008 certification, Universal Switching Corporation has demonstrated to ANAB accredited third party auditors (National Quality Assurance) that we have an effective Quality Management System in place. These include the following types of processes:

- Management responsibility
- Management review
- Resources and work environment
- Product realization
- Design and development
- Customer relations
- Measurement, analysis and improvement
- Purchasing
- Outsourcing
- Production and service provisions
- Control of monitoring and measuring devices
- Control of nonconforming product
- Analysis of data
- Continual improvement
- Corrective action
- Preventative action



Global Signal Switching and Distribution Specialists



Draw your secret design concept here.....

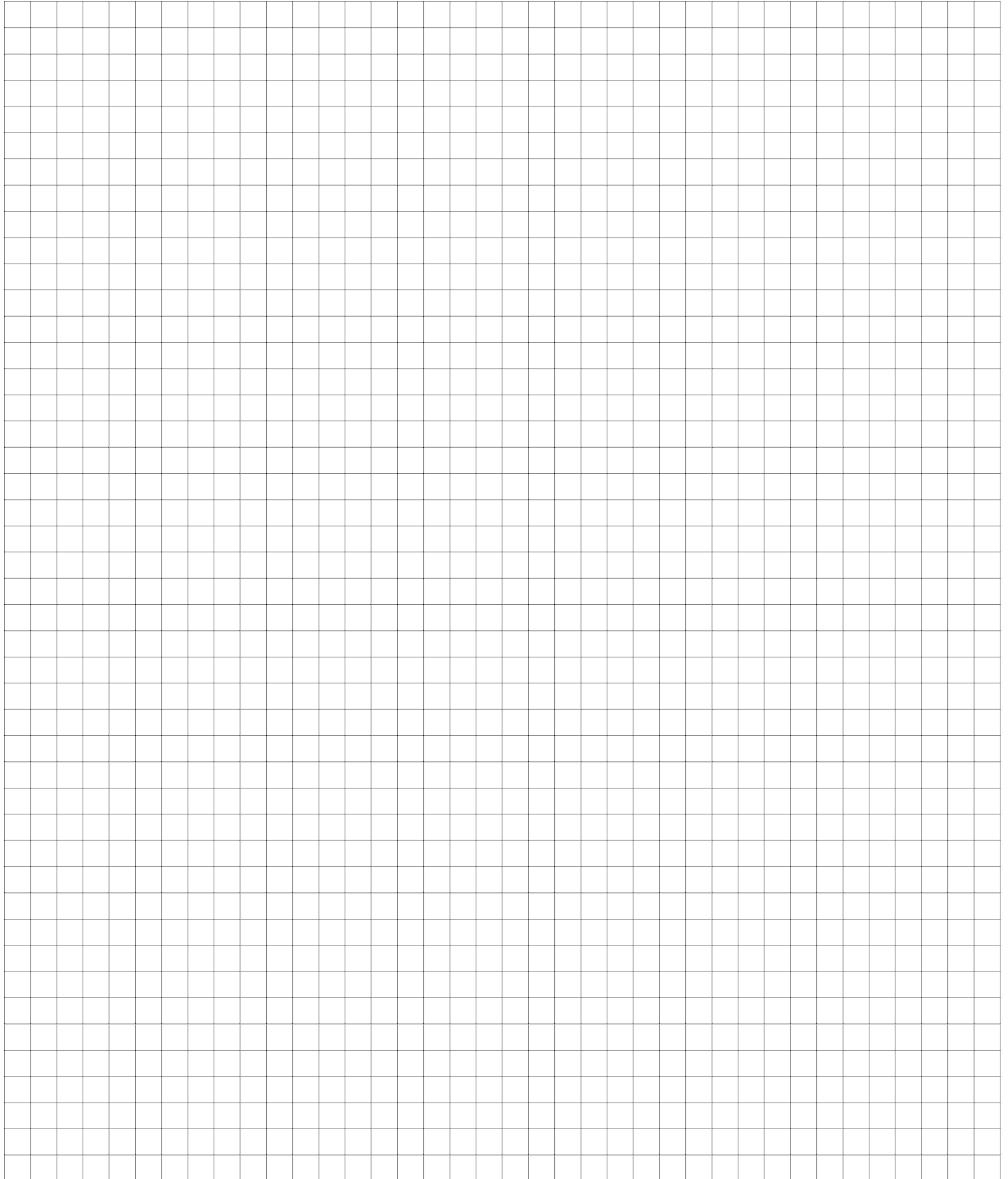

Grid = 0.200 x 0.200

Factory Authorized Representatives

Domestic and International Offices - March 2017

Alabama

Test Equipment Solutions
Phn: (256) 715-0820
TESllc.net

Alaska

Elotek Systems
Toll Free: (888) 435-6835
elotek.com

Arizona

Elotek Systems
Toll Free: (888) 435-6835
elotek.com

Arkansas

CentraMark
Phn: (972) 414-8188
cmatex.com

California

Elotek Systems
Toll Free: (888) 435-6835
elotek.com

Colorado

Elotek Systems
Toll Free: (888) 435-6835
elotek.com

Connecticut

Clafin Associates
Toll Free: (888) 252-3546
888clafin.com

Delaware

Clafin Associates
Toll Free: (888) 252-3546
Web: 888clafin.com

Florida

Test Equipment Solutions
Phn: (850) 797-0065
TESllc.net

Georgia

Test Equipment Solutions
Phn: (770) 876-7159
TESllc.net

Hawaii

Elotek Systems
Toll Free: (888) 435-6835
Web: elotek.com

Idaho

Elotek Systems
Toll Free: (888) 435-6835
elotek.com

Indiana

JR Johnson Associates
Toll Free: (800) 637-6775
jamesr.com

Illinois

JR Johnson Associates
Toll Free: (800) 637-6775
jamesr.com

Iowa

JR Johnson Associates
Toll Free: (800) 637-6775
jamesr.com

Kansas

JR Johnson Associates
Toll Free: (800) 637-6775
jamesr.com

Louisiana

CentraMark
Phn: (972) 414-8188
cmatex.com

Maine

Clafin Associates
Toll Free: (888) 252-3546
888clafin.com

Massachusetts

Clafin Associates
Toll Free: (888) 252-3546
888clafin.com

Maryland

Delmarva Engineering
Phn: (410) 990-9000
delmarva-eng.com

Michigan

JR Johnson Associates
Toll Free: (800) 637-6775
jamesr.com

Minnesota

JR Johnson Associates
Toll Free: (800) 637-6775
jamesr.com

Mississippi

Test Equipment Solutions
Phn: (850) 797-0065
TESllc.net

Missouri

JR Johnson Associates
Toll Free: (800) 637-6775
jamesr.com

Montana

Elotek Systems
Toll Free: (888) 435-6835
elotek.com

Nebraska

JR Johnson Associates
Toll Free: (800) 637-6775
jamesr.com

Nevada

Elotek Systems
Toll Free: (888) 435-6835
elotek.com

New Hampshire

Clafin Associates
Toll Free: (888) 252-3546
888clafin.com

New Jersey

Clafin Associates
Toll Free: (888) 252-3546
888clafin.com

New Mexico

Elotek Systems
Toll Free: (888) 435-6835
elotek.com

New York

Clafin Associates
Toll Free: (888) 252-3546
888clafin.com

North Carolina

Delmarva Engineering
Phn: (410) 990-9000
delmarva-eng.com

North Dakota

JR Johnson Associates
Toll Free: (800) 637-6775
jamesr.com

Ohio

JR Johnson Associates
Toll Free: (800) 637-6775
jamesr.com

Oklahoma

CentraMark
Phn: (972) 414-8188
cmatex.com

Oregon

Elotek Systems
Toll Free: (888) 435-6835
elotek.com

Pennsylvania

Clafin Associates
Toll Free: (888) 252-3546
Web: 888clafin.com

Rhode Island

Clafin Associates
Toll Free: (888) 252-3546
888clafin.com

South Carolina

Test Equipment Solutions
Phn: (478) 733-3279
TESllc.net

South Dakota

JR Johnson Associates
Toll Free: (800) 637-6775
jamesr.com

Tennessee

Test Equipment Solutions
Phn: (256) 715-0820
TESllc.net

Texas

CentraMark
Phn: (972) 414-8188
cmatex.com

Utah

Elotek Systems
Toll Free: (888) 435-6835
elotek.com

Vermont

Clafin Associates
Toll Free: (888) 252-3546
888clafin.com

Virginia

Delmarva Engineering
Phn: (410) 990-9000
delmarva-eng.com

Washington

Elotek Systems
Toll Free: (888) 435-6835
elotek.com

Washington D.C.

Delmarva Engineering
Phn: (410) 990-9000
delmarva-eng.com

West Virginia

Delmarva Engineering
Phn: (410) 990-9000
delmarva-eng.com

Wisconsin

JR Johnson Associates
Toll Free: (800) 637-6775
jamesr.com

Wyoming

Elotek Systems
Toll Free: (888) 435-6835
elotek.com

Australia

SouthTech Systems
Phn: +61-3-9459-4963
southtechsystems.com.au

Austria

Tel Data System GmbH
Phn: +49 8121-4101-18
teldatasystem.de

Bahrain

Glocom Ltd
Phn: +(917) 4-3792367
glocomltd.com

Belgium

EEMCCOIMEX
Phn: +31-320-295-395
eemc.nl

Brazil

Boreal Beta Communications Ltda
Phn: +55 (19)3258-2210
borealtec.com.br

Brunei

TME Systems Pte Ltd
Phn: +(65) 6747 7234
tmesystems.net

Denmark

Tony Chapman Electronics
Phn: +44-01992-578231
tceldt.co.uk

Egypt

SHIMCO Engineering Consultants
Phn: +202-330-36216

Estonia

Caltest Oy
Phn: +385-400-455443
caltest.fi

Finland

Caltest Oy
Phn: +385-400-455443
caltest.fi

France

Elnexionce
Phn: +33 (0)1 69 53 80 00
elnexionce.fr

Germany

Tel Data System GmbH
Phn: +49 8121-4101-18
teldatasystem.de

India

ITGlobe Incorporated
Phn: +91-11-26440720
itglobe.com

Indonesia

TME Systems Pte Ltd
Phn: +(65) 6747 7234
tmesystems.net

Ireland

Tony Chapman Electronics
Phn: +44-01992-578231
tceldt.co.uk

Israel

A.Telemetry LTD
Phn: +972-9-7450475
a-telemetry.com

Italy

Milano Brothers
Phn: +39-338.49.69.298
milanobro.com

Luxemburg

EEMCCOIMEX
Phn: +31-320-295-395
eemc.nl

Malaysia

TME Systems Pte Ltd
Phn: +(65) 6747 7234
tmesystems.net

Mexico

Grupo Etercom S.A.
Phn: +(55) 5539 43 76
etercom.com.mx

Netherlands

EEMCCOIMEX
Phn: +31-320-295-395
eemc.nl

New Zealand

SouthTech Systems
Phn: +61-3-9459-4963
southtechsystems.com.au

Norway

Tony Chapman Electronics
Phn: +44-01992-578231
tceldt.co.uk

People's Republic of China

New World Telecom
Phn: +86-755-33355930
newworldt.com

Philippines

TME Systems Pte Ltd
Phn: +(65) 6747 7234
tmesystems.net

Portugal

Gizatech
Phn: +34 917 216 630
gizatech.eu

Qatar

Glocom Ltd
Phn: +(917) 4-3792367
glocomltd.com

Saudi Arabia

Glocom Ltd
Phn: +(917) 4-3792367
glocomltd.com

Singapore

TME Systems Pte Ltd
Phn: +(65) 6747 7234
tmesystems.net

South Korea

SATCOMLINK Co., Ltd
Phn: +82-2-7532-0404
satcomlink.com

Spain

Gizatech
Phn: +91-917 216 630
gizatech.eu

Switzerland

Tel Data System GmbH
Phn: +49 8121-4101-18
teldatasystem.de

Taiwan (R.O.C.)

Everso Instruments Inc.
Phn: +886-2-2752-0767
evergo.com.tw

Thailand

TME Systems Pte Ltd
Phn: +(65) 6747 7234
tmesystems.net

United Arab Emirates

Glocom Ltd
Phn: +(917) 4-3792367
glocomltd.com

United Kingdom

Tony Chapman Electronics
Phn: +44-01992-578231
tceldt.co.uk

NOTE: For areas not mentioned on this list, please contact the factory directly.

