

## General

Designed for routing and distributing digital data in either synchronous or asynchronous modes, the System S2560F helps eliminate the use of manual patch bays and patch cords. It is a high-density all digital switch array specifically designed for routing single-ended and differential (422) digital signals such as RS-422, PCM, TTL, clock & data, RS-530, or other similar signals up to 50Mbps.

Fully populated, this 5RU unit contains 256 inputs and 256 outputs where a given input can be connected to one, many, or all 256 outputs (full fan-out non-blocking). The S2560FX is the same but has a 10.1" display (**Option X**) and additional front panel features.

The system is field configurable from a small 32x32, and expandable to a full 256x256 within the same chassis while in the field. To further expand, multiple units can be connected together for 512x512, or even sizes up to as large as 1024x1024.

The unit comes standard with redundant hot-swap power supplies, and is available with either single or dual (redundant) hot-swap C3 controllers installed. The C3 controller features 10/100 Ethernet (LXI certified), USB 2.0 and multi-serial (RS-232C/422A/485) control ports. System control & monitoring (and programming updates) is simple via the built-in web browser, or from our software package RouteWarePRO.

The optional I/O connector adapter panels allow the system to be multi-purpose for clock/data, '422, TTL, PCM, E1, or any combination depending upon the type of panel selected. Signals can be grouped together as clock and data on D-Sub connectors, or as Triax type (BJ-77), or on BNC for PCM type signals. The panels also allow the user to remotely locate the inputs or outputs from the actual system chassis. This allows a new higher level of flexibility for the system integrator. Contact your local sales representative or the factory for assistance.

## Applications

- Telemetry data TTL or PCM streams
- Clock and Data routing
- Differential 422 native I/O
- Data recorder data management
- Imaging and animation production facilities
- Production studios

## Features

- High reliability differential (422) digital design
- Optional 1RU adapter panels for '422, TTL or PCM
- Redundant digital signal paths (Tri-Stage)
- Designed specifically for digital switching
- Flexible configuration: 32x32 up to 256x256 (or larger)
- Multiple units can be grouped to configure 1024x1024
- Ultra-high density, over 65,500 crosspoint in 5RU
- DC to 50Mbps throughput
- Input activity monitoring included
- Hot-swap module technology
- Menu driven color touchscreen display (4.3" or 10.1")
- Available with either single or dual CPUs
- 10/100 Ethernet, USB and Serial control ports
- Includes TCP/IP, SNMP, IPv4 & IPv6 & web browser
- Removable microSD card for secure environments
- Rugged 5RU high aluminum chassis (8.75")
- International AC power range
- Self-monitoring hot-swap plug-in supplies with PFC
- Integrated rack mount design (19 inch)
- Chassis slide mounting hardware (slides not included)
- Certified CE EN61010 (LVD)
- Compatible with RouteWarePRO control software

SNMP

Powered

LXI

IPV6



Advanced C3 Controller  
Single or Dual



Download our Monitor & Control software **RouteWarePRO** for a FREE 30-day trial today!



System S2560FX  
(shown with 10.1" display)



System S2560F  
(shown with 4.3" display)

# Model Number Assignment

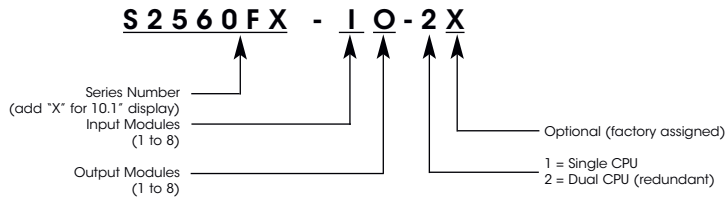

## Defining a System

### How to choose your features

The S2560F is a modular digital switching system comprised of plug-in modules installed into a 5RU mainframe. Plug-in modules provide a flexible architecture for configurations as small as 32 inputs, 32 outputs and can be expanded to a fully populated system providing 256 inputs and 256 outputs. Larger systems up to 1024x1024 can be realized by interconnecting multiple units.

The system model number and basic features can be specified by observing the definition above. First, choose how many input modules you will need, then the number of output modules remembering that each module provides 32 channels. When specifying a system, factory supplied filler plates cover unpopulated slots for proper system cooling.

Each input or output module provides 32 ports (16 differential ports per connector). The high density design of the system incorporates 50 position SCSI-II connectors. Each connector provides 16 differential ports.

Due to the compact size of the S2560F and unique Tri-Stage™ design, path-to-path skew is very small allowing the possibility to route both clock and data in the same unit, up to 128x128. If larger clock/data configurations are needed, then two S2560F units can be used to configure a dual 256x256 where clock signals would be routed by one unit and data signals routed by the other. Control of the system can be ganged so that both signals switch together under one command.

### Adapter Panels

Optional adapter panels provide other connection schemes (grouping two pairs for clock/data), various connector types, and even signal conversion (PCM or TTL).

The use of the optional I/O connector adapter panel assemblies provides a host of additional unique features such as individual connectors for each channel, grouping of signals for clock/data, or the simple ability to locate the system I/O connectors on the front of the equipment rack (or mixed, some on the front and some on the rear). The connector panel assemblies also allow the I/O to be located in a different rack from the actual switching system.

J1	Signal Name	J2	Signal Name
1	.....I/O 01 (+)	1	.....I/O 17 (+)
2	.....I/O 02 (+)	2	.....I/O 18 (+)
3	.....I/O 03 (+)	3	.....I/O 19 (+)
4	.....I/O 04 (+)	4	.....I/O 20 (+)
5	.....Ground	5	.....Ground
6	.....I/O 05 (+)	6	.....I/O 21 (+)
7	.....I/O 06 (+)	7	.....I/O 22 (+)
8	.....I/O 07 (+)	8	.....I/O 23 (+)
9	.....I/O 08 (+)	9	.....I/O 24 (+)
10	.....Ground	10	.....Ground
11	.....I/O 09 (+)	11	.....I/O 25 (+)
12	.....I/O 10 (+)	12	.....I/O 26 (+)
13	.....I/O 11 (+)	13	.....I/O 27 (+)
14	.....I/O 12 (+)	14	.....I/O 28 (+)
15	.....Ground	15	.....Ground
16	.....I/O 13 (+)	16	.....I/O 29 (+)
17	.....I/O 14 (+)	17	.....I/O 30 (+)
18	.....I/O 15 (+)	18	.....I/O 31 (+)
19	.....I/O 16 (+)	19	.....I/O 32 (+)
20	.....Ground	20	.....Ground
21	.....VEE (-V)	21	.....VEE (-V)
22	.....VEE (-V)	22	.....VEE (-V)
23	.....Ground	23	.....Ground
24	.....VDD (+V)	24	.....VDD (+V)
25	.....VDD (+V)	25	.....VDD (+V)
26	.....I/O 01 (-)	26	.....I/O 17 (-)
27	.....I/O 02 (-)	27	.....I/O 18 (-)
28	.....I/O 03 (-)	28	.....I/O 19 (-)
29	.....I/O 04 (-)	29	.....I/O 20 (-)
30	.....Ground	30	.....Ground
31	.....I/O 05 (-)	31	.....I/O 21 (-)
32	.....I/O 06 (-)	32	.....I/O 22 (-)
33	.....I/O 07 (-)	33	.....I/O 23 (-)
34	.....I/O 08 (-)	34	.....I/O 24 (-)
35	.....Ground	35	.....Ground
36	.....I/O 09 (-)	36	.....I/O 25 (-)
37	.....I/O 10 (-)	37	.....I/O 26 (-)
38	.....I/O 11 (-)	38	.....I/O 27 (-)
39	.....I/O 12 (-)	39	.....I/O 28 (-)
40	.....Ground	40	.....Ground
41	.....I/O 13 (-)	41	.....I/O 29 (-)
42	.....I/O 14 (-)	42	.....I/O 30 (-)
43	.....I/O 15 (-)	43	.....I/O 31 (-)
44	.....I/O 16 (-)	44	.....I/O 32 (-)
45	.....Ground	45	.....Ground
46	.....VEE (-V)	46	.....VEE (-V)
47	.....VEE (-V)	47	.....VEE (-V)
48	.....Ground	48	.....Ground
49	.....VDD (+V)	49	.....VDD (+V)
50	.....VDD (+V)	50	.....VDD (+V)

## Adapter Panel Assemblies

(for details, see individual data sheets)

### Series AP16D9S

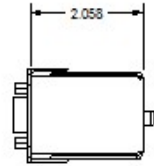
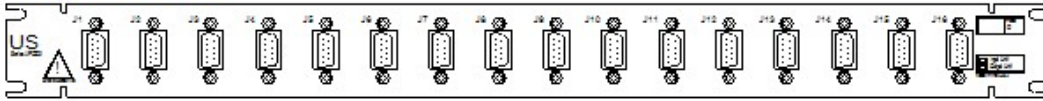

### Series AP16D9P

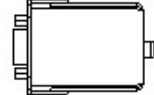
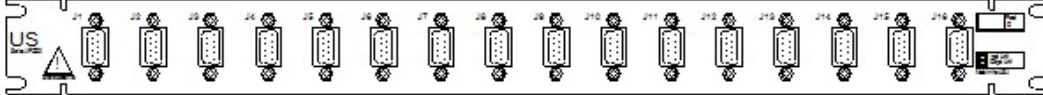

### Series AP32R



### Series AP32RS



### Series AP32BF

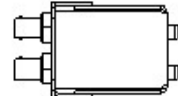

### Series AP32TF

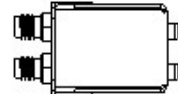

### Series AP32Tx

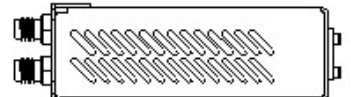

## Example 422 Clock/Data System: Dual 256x256

### 256 input, 256 output with RJ-45 adapter panels

Shown below is an example of two fully populated S2560F units (one for clock and one for data) with optional RJ-45 passive I/O adapter panels. These are individual 1RU high (1.75") rack mounted units (Series AP32RS) and serve the following functions:

- Provides individual standard RJ-45 connectors for the user
- Contains two channels on each RJ-45 (clock and data)
- Allows signal connectors to be located on front or rear of rack
- Ability to remotely locate user signal connectors
- Deliver high performance differential 100 ohm data switching

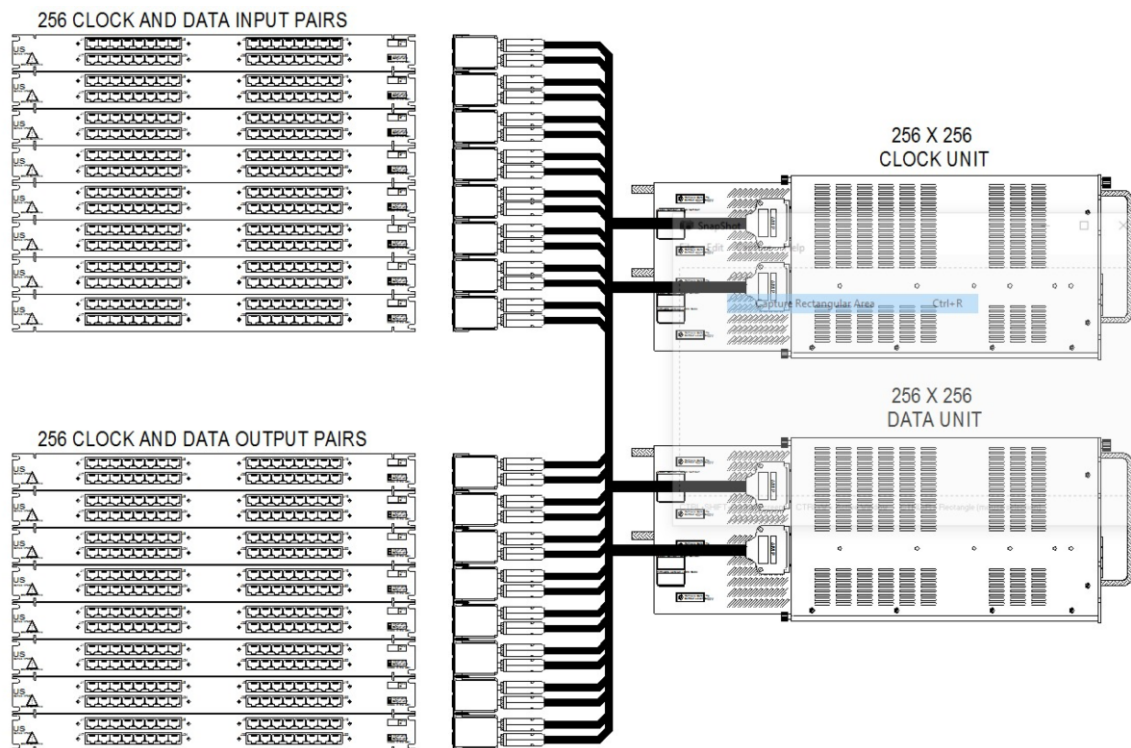

### System S2560F Specifications

Minimum array size . . . . .32 input, 32 output  
 Maximum array size . . . . .256 input, 256 output  
 Expansion increment . . . . .32 ports per module  
 Design capacity . . . . .1024 inputs, 1024 outputs \*\*  
 Switching technology . . . . .Digital  
 Type of system . . . . .Non-blocking with full fanout  
 Architecture . . . . .Tri-Stage redundant, uni-directional

\*\* Systems comprised of multiple units are individually controlled unless special Master/Slave unit is purchased.

#### Input Characteristics

Signal connector . . . . .50 position SCSI-II  
 Coupling . . . . .DC  
 Impedance . . . . .100 ohm (differential 422)  
 Input type . . . . .High-speed 422 receivers  
 Common mode . . . . .-7V to +12V

#### Output Characteristics

Signal connector . . . . .50 position SCSI-II  
 Coupling . . . . .DC  
 Impedance . . . . .100 ohm (differential 422)  
 Output type . . . . .High-speed, low skew differential drivers

#### Signal Characteristics with 50 or 75 ohm TTL Adapter Panels

Frequency response . . . . .DC-50Mbps  
 Input VSWR . . . . .<1.3:1

#### General Specifications

Module technology . . . . .Hot-Swappable  
 Power supply section . . . . .Redundant hot-swap standard  
 Controller CPU . . . . .Single or Dual (redundant)  
 Remote interface . . . . .10/100 Ethernet, USB & Serial (232/422/485)  
 Local control . . . . .Color touchscreen (4.3" or 10.1")  
 Configuration routing . . . . .AutoRoute or manual  
 Configuration memory . . . . .Flash  
 Cooling . . . . .Forced cooling with RPM monitoring  
 AC power requirements . . . . .90-264VAC, 47-440Hz, 400Watts  
 Power cords . . . . .Dual inputs (USA 15A)  
 Weight . . . . .50lbs  
 Size . . . . .8.75H x 22.00D x 19.00W (5RU)  
 Operating temp . . . . .0 to +50C  
 Non-operating temp . . . . .-20 to +85C  
 Humidity . . . . .0 to 95% (NC @ +25C)  
 MTBF . . . . .>15,000 hours (per MIL-HDBK-217F N1, ground benign @ +25C) estimated

#### Factory Spares

In-module (32 input) . . . . .VDI2560F-DD12A  
 Mid-module . . . . .VDM2560F-D01  
 Out-module (32 output) . . . . .VDO2560F-DD12A  
 Power supply element . . . . .PS2560F-200

Universal Switching's policy is one of continuous development, and consequently the company reserves the right to vary from the descriptions and specifications shown in this publication.